

CATEGORY	DESCRIPTION	P/N #	REV.	ECN NO	DESCRIPTION	REVISED	DATE
CONNECTOR	Modular Jack, 8P8C, R/A, With LED	MJ88-XX11-HRNVLX	A01		整理图画	XSY	2015.5.11

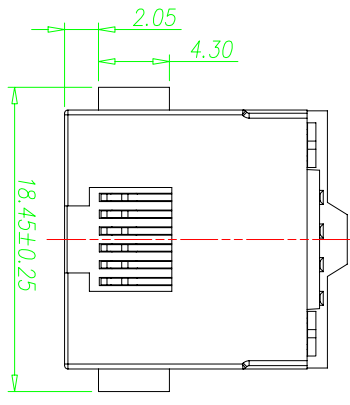

MJ88-XX11-HRNVLX

X	颜色	X	LED-L
Y	Yellow	B	Yellow
B	Black	D	Green

X	Terminal Plating
0	Au 1u" Plating
1	Au 3u" Plating
2	Au 6u" Plating
3	Au 15u" Plating
4	Au 30u" Plating

SPECIFICATION

- CURRENT RATING: 1.5AMPS
- VOLTAGE RATING: 125V AC
- INSULATION RESISTANCE: 500MΩ MIN.
- WITHSTAND VOLTAGE: AC1000V RMS 50Hz or 60Hz MIN.
- CONTACT RESISTANCE: 30mΩ MAX.
- DURABILITY: 750 MATING CYCLES
- OPERATING TEMPERATURE: -25°C~+70°C

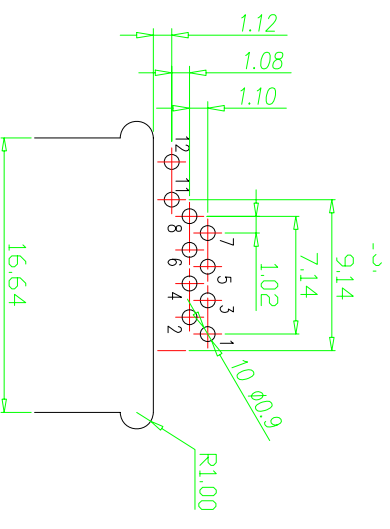
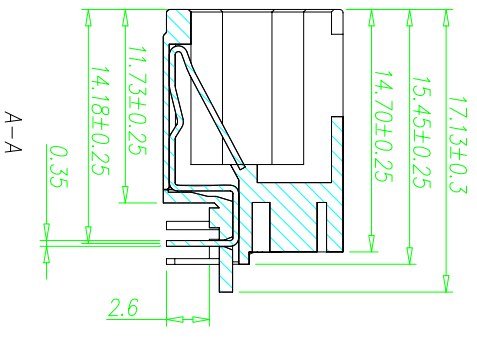
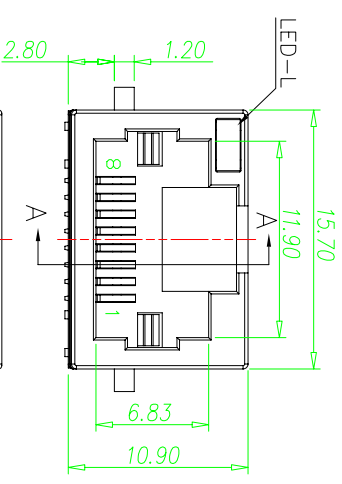

Recommend PCB Layout
Jack Top View
Tolerance: ±0.05mm
Recommend PCB Thickness: 1.6mm

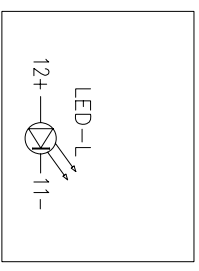
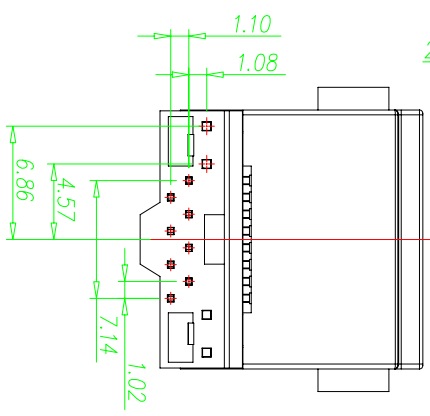

A 4 B C D 3 2 1

e	LED-R	1	SEE TABLE 1			
d	LED-L	1	SEE TABLE 1			
c	COVER	1	LOP+30%G.F UL94V-0	BLACK		
b	TERMINAL	8	PHOSPHOR BRONZE	Au/Tin PLATING		
a	HOUSING	1	LOP+30%G.F UL94V-0	BLACK		
NO.	PART NAME	QTY	MATERIAL	PLATING & COLOR	Remark	

UNLESS OTHERWISE SPECIFIED TOLERANCES

DECIMALS: ANGLES:

X : ±0.5 X : ±2°

X.X : ±0.3 X.X : ±1°

X.XX : ±0.2 X.XX : ±1°

东莞市合陵电子有限公司
 Dongguan Heling Electronic Co.,LTD

SCALE: 1/1 UNIT: mm

SIZE: A3 PAGE: 1 OF 1 REV: A01

APPROVED BY: XSY CHECKED BY: XSY PREPARED BY: XSY

DICK: XSY

CUSTOMER COPY